

MAZE FOR PRISMS

1. Each section of the maze contains a measurement. They are the volume, total area, or lateral area of the figures on the next page. Solve for the volume or area indicated and find the answers in the maze. Circle your answers.
2. Work until you can draw an unbroken path to the treasure room that goes only through rooms containing correct answers. The path might not go through all the correct answers.

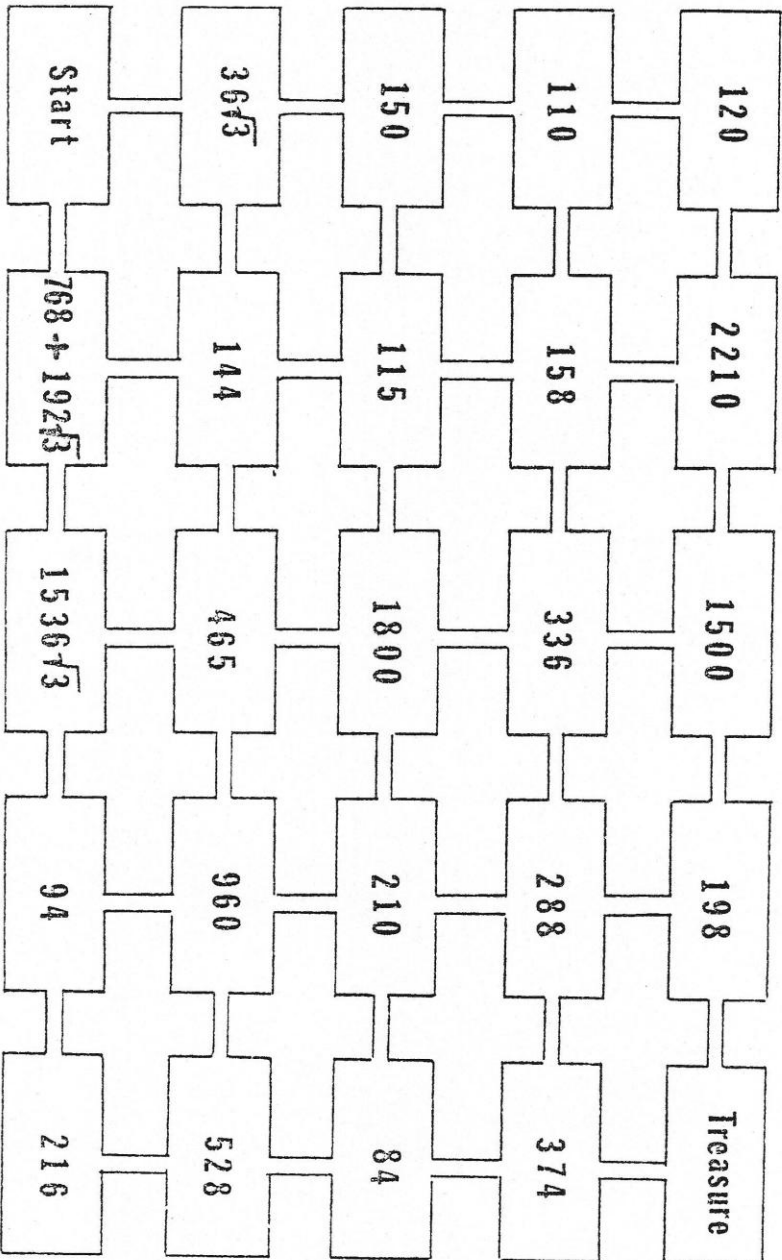

1.)

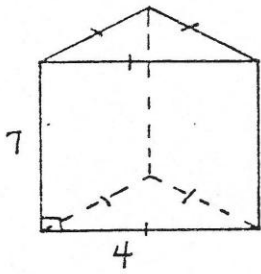

L.A. = _____

2.)

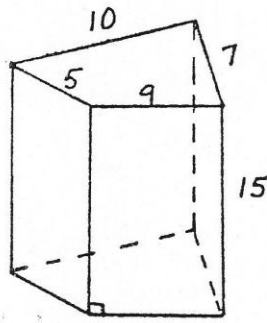

L.A. = _____

3.)

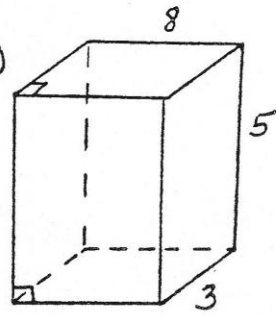

T.A. = _____

4.)

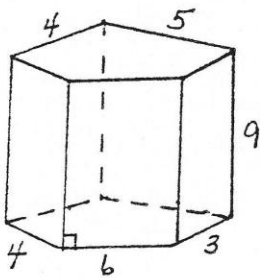

L.A. = _____

5.)

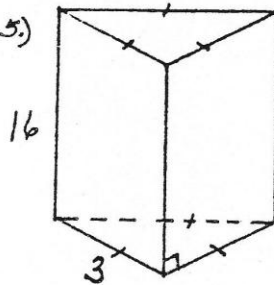

V = _____

6.)

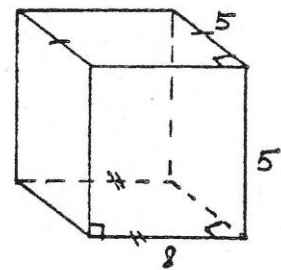

T.A. = _____

7.)

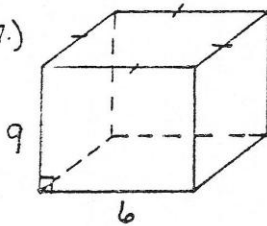

T.A. = _____

8.)

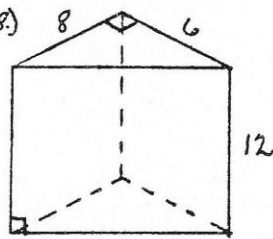

T.A. = _____

9.)

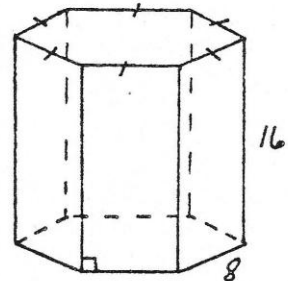

T.A. = _____

V = _____

10.)

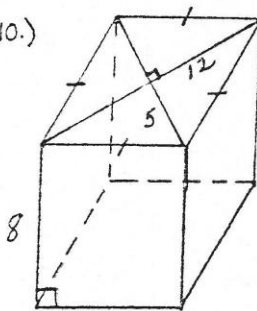

V = _____

11.)

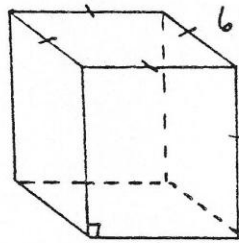

V = _____

12.)

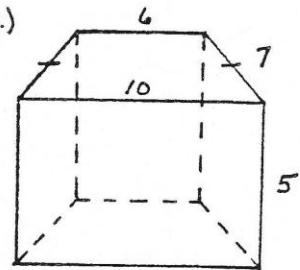

L.A. = _____